

## Package Styles

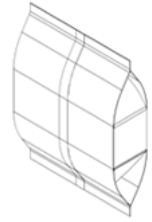

Gusseted/Tucked

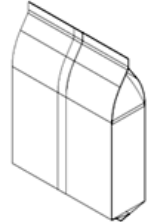

Flat Bottom



Quad-Seal Flat Bottom

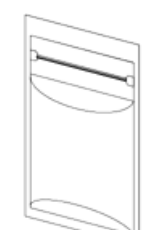

Reclosable Zipper

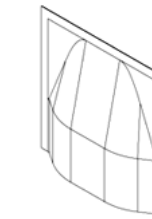

One Side Tucked

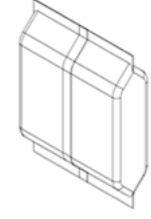

Pillow



## Total Systems Support Services

- Service by trained technicians based across the U.S.
- Experienced, teleservice support technicians available at no charge via phone, fax or email.
- Parts inventory to ensure the right part is available when you need it.
- The most efficient parts processing system in the packaging business.
- Reliable and timely parts shipment. We can deliver most parts within 24 hours, if requested.
- Formal training available in your plant or ours.
- Testing of your product and film.



- TELE SERVICE
- PARTS
- TRAINING
- PREVIOUSLY OWNED, CERTIFIED MACHINES



Proudly Made  
in the USA

## HayssenSandiacre

USA - 225 Spartangreen Boulevard • Duncan, SC 29334 USA • 864/486-4000  
 UNITED KINGDOM - 16 Roman Way • Thetford, Norfolk IP24 1XB United Kingdom • +44 (0) 1842 754171  
 UNITED KINGDOM - 101 Lilac Grove • Beeston, Nottingham, NG9 1PF • United Kingdom • +44 (0) 115 967 8787  
 MEXICO - Castorena 324-118 • Cuajimalpa • 05000 México, D.F. • +(52-55)5813-7770  
 www.hayssensandiacre.com • sales@hayssensandiacre.com

# HayssenSandiacre

## Vertical Frozen Food Packaging Systems

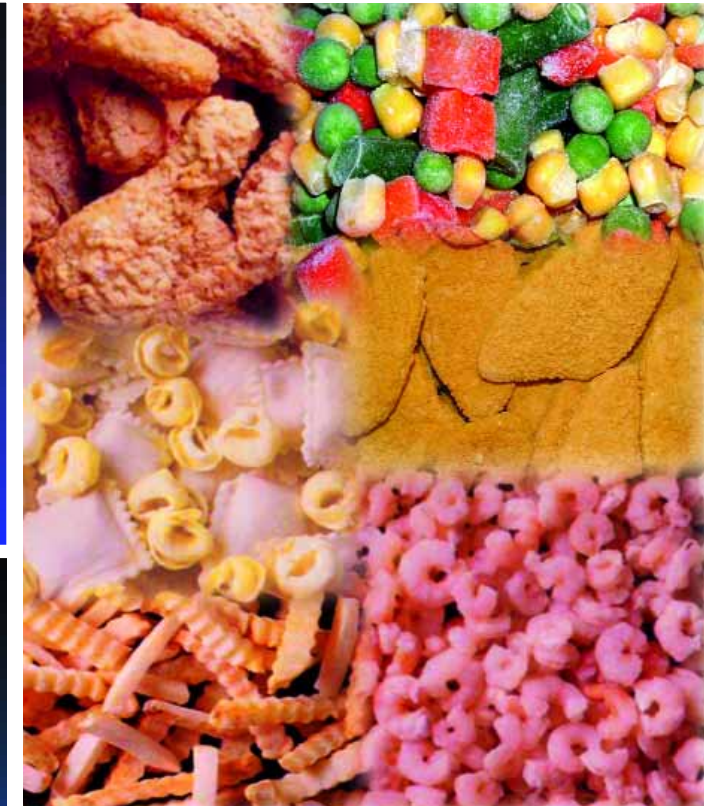
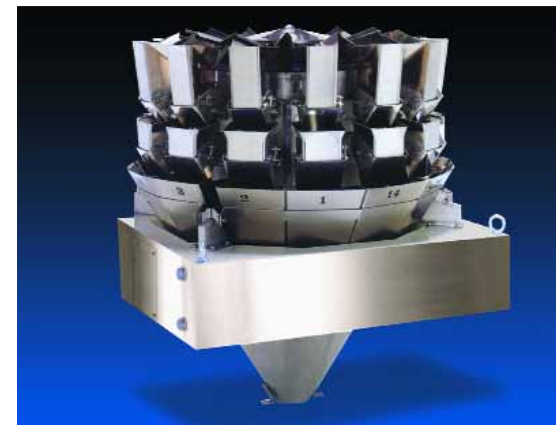

## HayssenSandiacre

has supplied rugged and dependable packaging systems for the severe service environment of the IQF industry for over half a century.

Contact HayssenSandiacre at 864-486-4000.

# Barry-Wehmiller

ACCRAPLY

Barry-Wehmiller  
International Resources

pneumatic  
SCALE ANGELUS  
HayssenSandiacre

PC  
MarquipWardUnited

Thiele  
Technologies

DESIGN GROUP  
FleetwoodGoldcoWyard



The Ultima SV - Intermittent Motion

## IQF Product Line

With its many years of experience in the application of meat, poultry, seafood, pasta, french fries and rolls HayssenSandiacre delivers the high quality, durability and unsurpassed performance that you should expect from a machine.

Our machines meet the rigid sanitary specifications necessary for the harsh and demanding environment of the IQF industry.

With over 10,000 systems installed throughout the world, HayssenSandiacre has the experience and the dedicated resources to support you wherever you are located, every day of the year.

Hayssen provides custom packaging solutions to meet your specific industry needs. We offer several options within the **HayssenSandiacre Ultima Family (ST, SU, SV, TR)** of vertical form/fill/seal machinery and computer combination net-weigh scales — all built specifically for frozen food applications.

## SEVERE SERVICE EXPERIENCE

HayssenSandiacre engineers and manufactures the most durable, dependable packaging systems in the industry. By designing and using robust, quality components, HayssenSandiacre never compromises the longevity and reliability of the performance of Hayssen packaging systems. HayssenSandiacre machines have performed reliably for decades in the severe service environments

Only HayssenSandiacre provides the rugged reliability and the **total systems support services** to keep you running day in, day out, for the long haul.

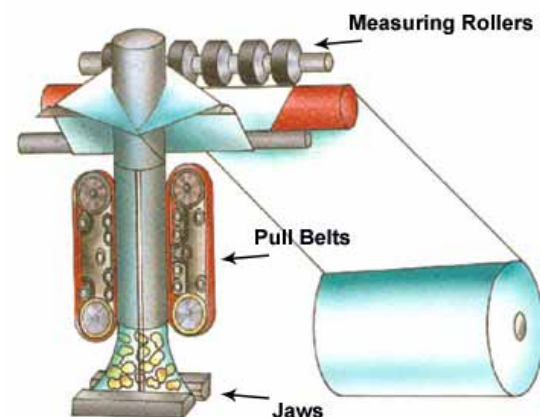

HayssenSandiacre's patented Measure, Form, Pull system is the fastest, production-proven way to package food.

## ULTIMA TR CONTINUOUS MOTION, POLYETHYLENE PACKAGING

- **Quali-Seal, EZseal and Measure, Form, Pull** combined to give you the highest poly speeds in the business.
- Produces consistent, **high-quality back seals** using servo driven, continuous metal band seal — including a back-off feature — to avoid burn through during product interruption.
- **Intelligent Motion Control** processing adjusts speed to product delivery, reducing film and product waste and downtime.
- **One screen** contains the most frequently used parameters, eliminating the need to search multiple screens for setup.
- **Speeds** may be changed **“on the fly”** from the touch screen, resulting in less downtime.



Ultima TR - Continuous Motion



Ultima with Integrated Zipper

## EZSEAL JAW OPTION

Since the introduction of the **Quali-Seal** and **Measure, Form, Pull** features in 1986, Hayssen has enjoyed the highest speeds and highest seal integrity on polyethylene films in the industry.

Now, **EZseal** adds to the HayssenSandiacre advantage with the introduction of tapeless poly-sealing jaws! No taping means less downtime, lower seal temperatures and higher speeds to produce the very best polyethylene seals in the business!

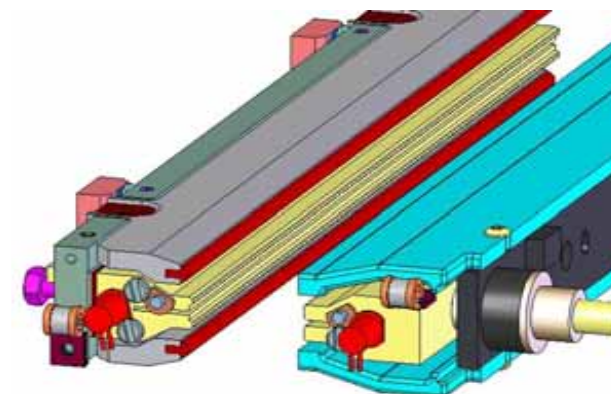

EZseal Sealing System for Polyethylene eliminates the need for tape.

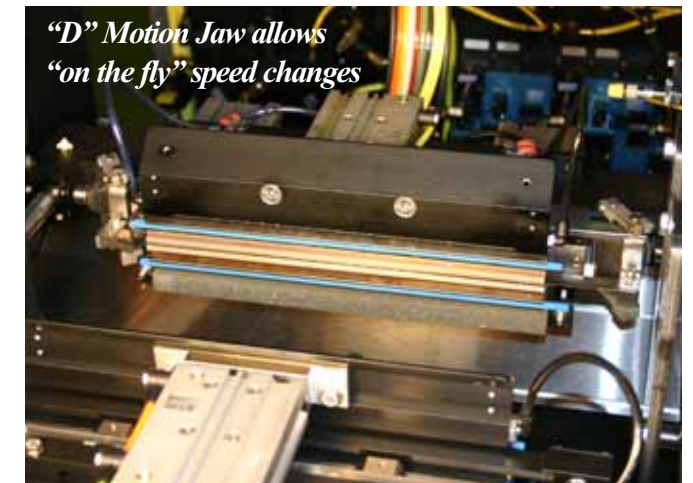

“D” Motion Jaw allows “on the fly” speed changes



**EXPERIENCE - PRIDE - EXCELLENCE**